

## Neutrons from Piezonuclear Reactions

FABIO CARDONE <sup>1</sup>, GIOVANNI CHERUBINI <sup>2,3</sup>, ROBERTO MIGNANI <sup>4,5</sup>,  
WALTER PERCONTI <sup>1</sup>, ANDREA PETRUCCI <sup>1</sup>, FRANCESCA ROSETTO <sup>6</sup>  
AND GUIDO SPERA <sup>7</sup>

<sup>1</sup>Istituto per lo Studio dei Materiali Nanostrutturati (ISMN — CNR)  
Via dei Taurini - 00185 Roma, Italy

<sup>2</sup>ARPA Radiation Laboratories Via Montezebio - 01100 Viterbo, Italy

<sup>3</sup>Facoltà di Medicina, Università degli Studi “La Sapienza”  
P.le A. Moro, 2 - 00185 Roma, Italy

<sup>4</sup>GNFM, Istituto Nazionale di Alta Matematica “F. Severi”  
Città Universitaria, P.le A. Moro 2 - 00185 Roma, Italy

<sup>5</sup>Dipartimento di Fisica “E. Amaldi”, Università degli Studi “Roma Tre”  
Via della Vasca Navale, 84 - 00146 Roma, Italy

<sup>6</sup>ARPA Chemical Laboratories Via Montezebio - 01100 Viterbo, Italy

<sup>7</sup>CRA - IS.Pa.Ve., Chemical Section  
Via C.G. Bertero, 22 - 00156 - Roma, Italy

**ABSTRACT.** We report the results obtained by cavitating water solutions of iron salts ( $Fe(Cl)_3$  and  $Fe(NO_3)_3$ ) with different concentrations at different ultrasound powers. In all cases we detected a neutron radiation well higher than the background level. The neutron production is perfectly reproducible and can at some extent be controlled. These evidences for neutron emission generated by cavitation support some preliminary clues for the possibility of piezonuclear reactions (namely nuclear reactions induced by pressure and shock waves) obtained in the last ten years. We have been able for the first time to state some basic features of such a neutron emission induced by cavitation, namely: 1) a marked threshold behavior in power, energy and time; 2) its apparent occurring without a concomitant production of  $\gamma$  radiation.

### 1 Introduction

Acoustic cavitation of liquids with gas dispersed consists in subjecting them to elastic waves of suitable power and frequency (in particular to ultrasounds) [1, 2]. The main physical phenomena occurring in a cavitating liquid (e.g. sonoluminescence [3]) can be accounted for in terms of a hydrodynamic model based on the formation and the collapse of gas

bubbles in the liquid [1, 2]. Three different experiments on cavitation carried out in the last years [4, 5, 6] provided evidence for an anomalous production of intermediate and high mass number (both stable, unstable and artificial) nuclides within samples of water subjected to cavitation, induced by ultrasounds with 20 KHz frequency. Those results together seem to show that ultrasounds and cavitation are able to generate nuclear phenomena bringing to modifications of the nuclei involved in the process. A model able to account for such nuclear reactions induced by high pressures (called in this paper *piezonuclear reactions*), based on the implosive collapse of the bubbles inside the liquid during cavitation, has been proposed by two of the present authors (F.C. and R.M.) [7]. Notice that, in the first experiments that we carried out, proton number was practically conserved, whereas neutron number was apparently not [4, 5]. This constitutes an indirect hint of some sort of neutron production in such cavitation processes. Since, as is well known, nuclear reactions in most cases involve neutron emission, it is a fundamental issue to check whether neutrons are produced indeed in processes possibly involving piezonuclear reactions. We point out that some experiments carried out [8]-[16] in the last years have shown that cavitation of deuterated acetone can produce neutrons. In order to shed some light on this issue of neutron emission during cavitation, in 2004-2006 we carried out some experiments in which we cavitated controlled solutions of salts in water at CNR National Laboratories (Rome 1 Area) and Italian Armed Forces technical facilities. We focused our attention on ionising radiation and neutron emission. The details of these experiments are reported in the following.

## 2 Experimental Equipment

The employed ultrasonic equipment was the robust ultrasound welder DN20/2000MD by Sonotronic [17]. We slightly modified the piezoelectric and the sonotrode configuration in order to provide the equipment with a compressed air cooling system which allowed it to work for 90 minutes without stopping, at a frequency of 20 KHz. As cavitation chamber, we used a Schott Duran® vessel made of borosilicate glass of 250 ml and 500 ml [18]. The truncated conical sonotrode that conveyed ultrasounds was made of AISI grade 304 steel. His dimensions (length, long diameter, short diameter) and the dimensions of the threaded stub by which it was screwed on the booster-piezoelectric unit were and have to be designed in order to match the frequency of the mechanical oscil-

lations and reduce as much as possible any reflected power, i.e. in order to have the maximum ultrasonic power transfer. This adaptive design of the sonotrode is not unique but it is something which has to be done case by case and strongly depends on the material that the sonotrode is made of. Of course, once the long and short diameters of the truncated cone are fixed the length of sonotrode cannot just be determined by matching the resonance condition, but there is a further constraint to be taken into account. This constraint is the immersion of the sonotrode in the solution where ultrasounds have to conveyed which has also to allow for the diameter of the circular aperture of the vessel. We designed its length in order to have a maximum immersion depth of about 4 cm and a corresponding distance between the sonotrode tip and the bottom of the vessel of about 5 cm.

All these geometrical dimensions are crucial to the positive outcomes of the experiments as it will be clear further on. In all the experiments, the cavitated solutions were made of deionized and bidistilled water (18.2 M $\Omega$ ). Measurements of ionizing ( $\alpha$ ,  $\beta$  and  $\gamma$ ) radiation background were carried out, along with measurements of neutron radiation background. We used three types of detectors of ionizing radiation: geiger counter Gamma Scout [19] with a mica window transparent to  $\alpha$ ,  $\beta$  and  $\gamma$  radiation, and provided with two aluminium filters 1 mm and 3 mm thick, to screen  $\alpha$  radiation and  $\alpha$  and  $\beta$ , respectively; polycarbonate plate detectors PDAC CR39 sensitive to ionizing radiation in the energy range 40 keV -4 MeV and Tallium (Tl) activated, Sodium Iodine (NaI),  $\gamma$ -ray spectrometer GAMMA 8000 [20].

The radiations  $\alpha$ ,  $\beta$  and  $\gamma$ , measured in all the cavitation runs, turned out to be compatible with the background radiation<sup>1</sup>.

A magnetometer was used in order to take under control the local magnetic field (always found compatible with the local magnetic field of Earth, measured in absence of cavitation) and along with it possible currents generated by the converting piezoelectric units that might have affected the electronics of the geiger counters and of the gamma spectrometer. Besides, in order to avoid any possible interference through the power supplying wires and any possible spurious communication among the electronic detectors through the ground wire, the only electronic equipment to be connected to the power network was the 20 KHz oscillation generator while all the detectors were battery supplied.

---

<sup>1</sup>This agrees with the results on the absence of radiation emission in the first cavitation experiments [4, 5].

Let's now focus our attention on the technique used to reveal the possible neutron emission that we may expect during cavitation according to the results of our previous experiments [4, 5, 6]. The only hint that we got from these experiments is the non conservation of the number of neutrons according to the mass spectrometer analyses. In other words, the only thing that we could expect was a possible neutron emission but absolutely nothing could be said about its spectrum, its isotropy and homogeneity in space and its constancy in time which could be the most variable in terms of energy space and time. This wide range of possibilities convinced us that the first step to be moved in order to ascertain this hint was just to reveal the presence of neutrons in a sort of a 'yes or no' detecting procedure and leave a complete and more exhausting proper measurement to a second higher and more accurate level of investigation grounded on the possible positive answer from this first level of inquiry. Thus, we made our choice and decided to use neutron passive detectors which are capable of integrating neutron radiation within their energy range regardless of the time feature of their emission. The passive detectors that we used are called Defenders and are produced by BTI (Bubble Technology Industries)<sup>2</sup>.

They consist of minute droplets of a superheated liquid dispersed throughout an elastic polymer gel. When neutrons strike these droplets, they form small gas bubbles that remain fixed in the polymer. The number of bubbles is directly related to the amount and the energy of neutrons, so the obtained bubble pattern provides an immediate visual record of the neutron dose<sup>3</sup> (see Fig.1).

---

<sup>2</sup>Let us notice that they are no longer in production and have been replaced by similar devices. However on the BTI there still is a web page dedicated to them [21]

<sup>3</sup>Each Defender was provided with its own calibration number (number of bubbles/mRem) by which it was possible to convert the number of bubbles into dose equivalent.

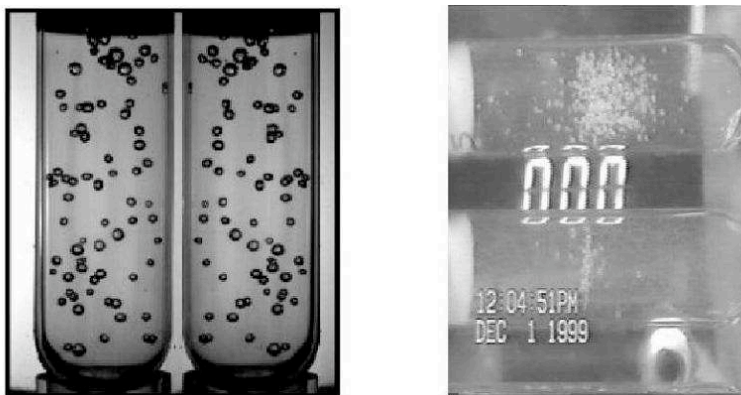

**Fig. 1:** Morphology and distribution of bubbles produced in a Defender by the passage of neutrons (left); heavy ions (right). In the second picture, the ion beam goes from bottom to top.

We will be presenting two sets of experiments during which two different kind of bubble detectors were used: Defender and Defender XL. Their specifications are slightly different and will be reported later on within each section describing a specific set of experiments. Before moving on to the presentation of the experiments and their results, it is important to stress at this stage some features of these passive detectors and state what was done in order to keep them under control. By doing this, we will also show that the whole of neutron measurements of the first and second investigation can be read as a sequence of control experiments which allowed us to crosscheck by each of them the accuracy of the previous one. The appearance of bubbles in these detectors can be brought about by different sources. Since the droplets are in a metastable state they can be affected by heat and mechanical compressions, just like ultrasounds. As to the heat, the first thing that has to be stressed is that these detectors are temperature compensated and their correct operation is guaranteed in the range from  $15^{\circ}\text{C}$  to  $35^{\circ}\text{C}$ . Besides, the laboratory (a small room) temperature was kept constant at about  $20^{\circ}\text{C} \pm 1^{\circ}\text{C}$  by a heat pump that could work in reverse mode as well. Of course we monitored by an infrared thermometer the temperature of the Defenders all over their body and with particular care on the area nearer to the vessel that became warm during cavitation. The temperature of this specific part never exceeded  $26^{\circ}\text{C}$  which is well within the

working temperature guaranteed by the manufacturer. By comparing the number of bubbles that popped up during each of the experiments of the first and second investigation, one can unmistakably state that they cannot be brought about by heat since all of the temperature increases of the solutions treated by ultrasounds in all of the experiments were always compatible with each other within  $\pm 5^{\circ}\text{C}$ , while the number of bubbles ranged from less than ten up to 70 depending on the applied ultrasonic power and the concentration of the solutions. Let's now say something about the second possible source of bubbles, i.e. ultrasounds. The minute droplets contained inside the polymer gel are turned into bubbles as they receive the correct amount of energy. Of course this amount can be conveyed to them by mechanical compressions just like ultrasounds. Despite that, as it will be clearly shown by the outcomes presented in the description of the experiments, ultrasounds cannot be considered the cause of the bubbles since the number of bubbles ranged from zero up to 70 while the power of ultrasounds, the distance between the vessel and the detector were always the same and being mechanical vibrations the cause of the bubbles, their number should have always been nearly constant.

### 3 Experimental Results

#### 3.1 First Investigation

Two separate investigations have been carried out. In the first one, we subjected to cavitation five solutions of pure water and four different salts in  $\text{H}_2\text{O}$ :

- 250 ml of bidistilled deionised water;
- 250 ml with a concentration of 1 ppm of Iron Chloride  $\text{FeCl}_3$ ;
- 250 ml with a concentration of 1 ppm of Aluminium Chloride  $\text{AlCl}_3$ ;
- 250 ml with a concentration of 1 ppm of Lithium Chloride  $\text{LiCl}$ ;
- 500 ml with a concentration of 1 ppm of Iron Nitrate  $\text{Fe}(\text{NO}_3)_3$ .

Each of the first four cavitations lasted 90 min, while the Iron Nitrate solution was cavitated both for 120 minutes. The schematic layout of the experimental equipment is shown in Fig. 2.

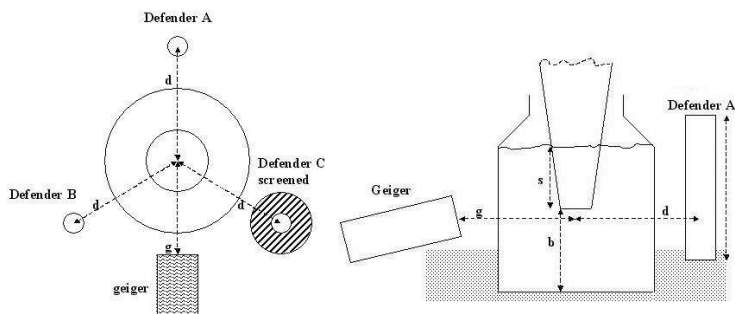

**Fig. 2:** Layout and lateral section of the experimental setup.  $d=7$  cm,  $g=10$  cm,  $s=4$  cm,  $b=5$  cm. This setup indicates that between the cavitation area and the neutron detectors and the Geiger counter there were 3.5 cm of water, the thickness of the Borosilicate (about 2 mm) and few centimetres of air.

The cavitation chamber (vessel) was in the centre and the sonotrode has to be imagined perpendicular to the plane of the figure, just over the bottle and lined up with it. The immersion of the sonotrode and the distance of its tip from the bottom of the vessel were about 4 cm and 5 cm respectively. For each cavitation experiment, we used three neutron detectors Defender. They are cylinders 194 mm long (their active part is 100 mm long) and with a diameter of 21 mm. They are sensitive to neutrons in the energy range between 10 KeV and 15 MeV. Their response is dose rate independent and their minimum detection level is a tenth of an ounce of Plutonium in seconds at 1 meter. Their response was determined to be about 100 counts/ $\mu$ Sv to  $^{252}\text{Cf}$  at 20°C. Their angular response is isotropic and they are completely unaffected by gamma radiation as it is stated by the manufacturer and it was experimentally ascertained by irradiating them with a known source of  $^{60}\text{Co}$  for several minutes without producing the tiniest bubble. They were placed vertically and parallel to the vessel or the sonotrode axis, arranged as shown in Fig. 2. One of the Defenders was screened by immersing it in a cylinder of carbon (moderator) 3 cm thick. The Geiger counter was pointed towards the area inside the bottle where cavitation took place. A second equal arrangement of three Defenders and the vessel containing the same uncavitated solution (blank), was placed in a different room and was used to measure the neutron radiation background at the same

time when cavitation was taking place. The measurements of fast neutron radiation carried out in the experiments with  $\text{H}_2\text{O}$ , Aluminium Chloride and Lithium Chloride were compatible with the background level (20 nSv). On the contrary, in the second and the fifth experiment, with Iron Chloride and Iron Nitrate respectively, the measured neutron radiation was incompatible with the neutron background level. The ultrasound power and the experimental setup were the same for all of the five experiments but only in two out of five we got a neutron signal higher than the background. This evidence rules out ultrasounds as the possible cause of bubbles in the Defenders. Neither could be the heat generated by ultrasounds in the solutions since their temperature and its rising time was always the same. Anyway, the temperature of the body of the defenders never exceeded the starting temperature ( $20^\circ\text{C}$ ) by more than  $3^\circ\text{C}$  being perfectly within the range guaranteed and recommended by the manufacturer. In the last thirty minutes of cavitation of the iron salt solutions, the measured dose ( $\sim 100$  nSv) was significantly higher than (even 5 times) the background<sup>4</sup>

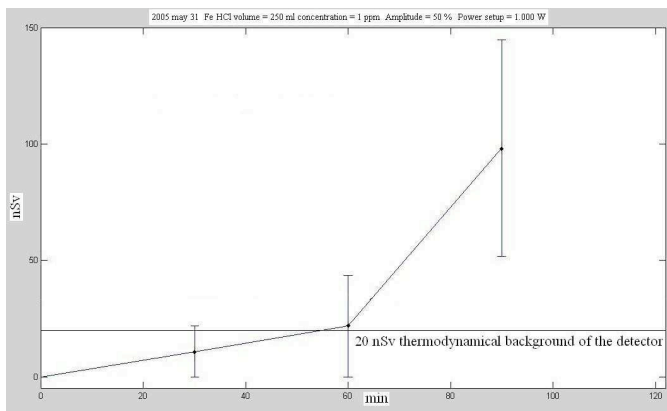
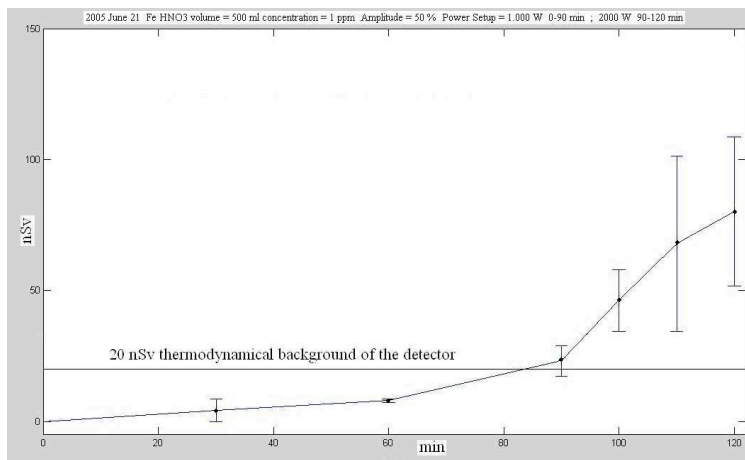

**Fig. 3:** Neutron dose (nSv) vs. cavitation time for  $\text{Fe}(\text{Cl})_3$  solution. The horizontal line represents the background level.

<sup>4</sup>The neutron background measurements were carried out at the same time of the cavitation, but in a different room, by means of equal detectors placed around a similar vessel containing the same solution. The results obtained were compatible with the background. The same compatibility was found with detectors immersed in carbon both in presence and in absence of cavitation. This last result is a further confirmation of the neutronic origin of the bubble signals in the Defenders.



Precisely, the final measured dose was  $(98.50 \pm 4.5)$  nSv for  $\text{FeCl}_3$  (Fig. 3) and  $(76.00 \pm 4.5)$  nSv for  $\text{Fe}(\text{NO}_3)_3$  (Fig. 4).



**Fig. 4:** Neutron dose (nSv) vs. cavitation time for  $\text{Fe}(\text{NO}_3)_3$  solution. The horizontal line represents the background level.

The horizontal black line represents the sum of the measured thermodynamical instability of the detectors<sup>5</sup> and of the measured neutron background level and is equal to 20 nSv. In both graphs, the values correspond to the mean of the two equivalent doses obtained by the two defenders without moderator used during cavitation<sup>6</sup>. The error bars were determined by taking the root mean square of the differences of the two equivalent doses and the mean value. The increase of the derivative that appears quite evidently in the last 30 minutes may be read as a first corroborating evidence for the phenomenological considerations proposed in [7], where two of us (F.C. and R.M.) proposed the existence

<sup>5</sup>Indeed, when the detectors are activated one faces an initial thermodynamical instability due to the almost sudden decrease of pressure applied on the superheated droplets dispersed in the gel. Some of them evaporate and form bubbles which have to be taken into account as a background level of blindness of the detector beyond a real, although very low, neutron background level.

<sup>6</sup>The number of bubbles was visually determined by two of the experimenters independently and the mean value of the two counts (which were always absolutely compatible and almost always equal to each other) was taken as the number of bubbles to calculate the dose.

of a threshold in power and energy (and hence time) for piezonuclear reactions to happen. In this sense, provided the ultrasonic power transmitted into the solution is higher than the required threshold [7], the emission of neutrons produced by these reactions begins only after that a certain amount of energy was conveyed into the solution or, which is equivalently, after a certain time interval. Let's now add a consideration which can be drawn from reference [7] where the bubble collapse is indicated as the main microscopical mechanism to induce piezonuclear reactions and hence neutron radiation. The emission of neutrons does not take place as from a stable source but, conversely, it happens in bursts. This consideration can be considered at this stage as a heuristic hypothesis which will be helpful in interpreting the results of the second investigation, nevertheless some experimental evidences presented further on will turn it into a sound empirical hypothesis. The last fact of this first investigation was the absence of ionizing radiation above the background level in all of the experiments - even in those two in which we got the evidence of neutron emission. Of course, this could mean either that gamma radiation was not emitted at all as it usually is when neutrons are emitted, or that the sensitivity of our detectors was not sufficient to reveal their slight presence. Besides, we have to point out that even if neutron emission took place without any consequent gamma radiation<sup>7</sup> from nuclei de-excitation, one would expect gamma rays to be emitted from hydrogen capture anyway. This first investigation permitted therefore to state that only the presence of Iron in the cavitated solution gives rise to fast neutron emission and therefore to nuclear processes induced by cavitation.

### 3.2 *Second Investigation*

Since the first investigation highlighted the basic role of Iron in producing piezonuclear reactions, the second one was devoted to a systematic study of such an evidence, by using solutions with only Iron Nitrate, since it gave rise, in the previous investigation, to the maximum flux of emitted neutrons. Then, six cavitation runs (each lasting 90 min) were carried out on the same quantity (250 ml) of pure water and of a solution of  $\text{Fe}(\text{NO}_3)_3$  with different concentration, subjected to ultrasounds of different power. Namely, the cavitated solutions could have three possible concentrations, 0 ppm ( $\text{H}_2\text{O}$ ), 1 ppm and 10 ppm. Moreover, the oscil-

---

<sup>7</sup>A possible explanation of this fact, based on a space-time deformation of the interaction region between two nuclei, can be found in ref. [7].

lation amplitude and hence the transmitted ultrasonic power took two different values, 50% and 70%, corresponding to about 100 W and 130 W, respectively. The energy delivered to the solution within the whole cavitation time was 0.54 MJ and 0.70 MJ in the two cases. In order to measure neutron radiation we employed five neutron detectors of the Defender XL type, with higher sensitivity (by one order of magnitude) with respect to those used in the first investigation. These detectors are cylinders 47 cm long (their active part is 30cm long) with a diameter of 5.7 cm. Their energy range lies between 10 KeV and 15 MeV. Their response is dose rate independent and their minimum detection level is a hundredth of an ounce of Plutonium in seconds at 1 meter. Their response was determined to be about 1000 counts/ $\mu$ Sv to  $^{252}\text{Cf}$  at 20°C. Their angular response is isotropic and they are completely unaffected by gamma radiation as it is stated by the manufacturer and it was experimentally ascertained by irradiating them with a known source of  $^{60}\text{Co}$  for several minutes without producing the tiniest bubble. Background neutron measurements were accomplished at the beginning of the whole set of cavitations. During each cavitation we carried out ionizing radiation measurements by two Geiger counters Gamma Scout [19], one with no aluminum filter and the other with a 3 mm filter, used simultaneously. One picture and a layout of the experimental apparatus used in the six cavitation runs are shown in Fig. 5.

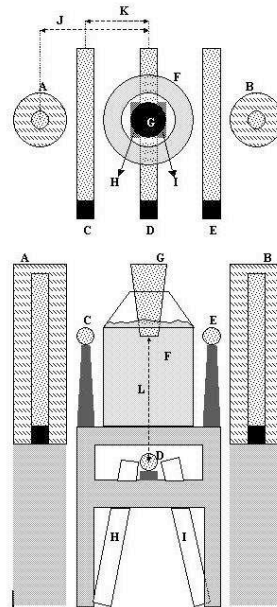

**Fig. 5:** Experimental apparatus used in the second investigation. The cavitation Chamber (F) is visible in the middle of both pictures and the sonotrode, the vertical tapered metal stick (G), is aligned with and inserted in it. The green pipe surrounding the sonotrode conveyed the cooling air onto the sonotrode surface. The three horizontal greyish cylinders (C,D,E) with a black cylindrical endcap are the neutron detectors. The two orange (right) (B) and creamy (left) (A) vertical cylinders contained the two screened Defenders, one by boron (orange) and the other by carbon (creamy).

The vessel in which cavitation took place (F) (cavitation chamber, the same as the first investigation) is visible in the middle of both pictures and the sonotrode, the vertical tapered metal stick, is aligned with and inserted in it. The three horizontal greyish cylinders with a black cylindrical endcap are the neutron detectors. Two of them (C) and (E) were positioned next to the chamber at a height with respect to the tip of the sonotrode, in order to be struck by horizontally emitted neutrons. Their distance (K) from the centre of the vessel is half the diameter of

the bottle (3.5 cm of water) plus the thickness of the borosilicate glass 2 mm and 5 mm of air. The third detector (D) was placed underneath the chamber in order to collect the vertically emitted neutrons. Since in this second investigation we reduced the immersion of the sonotrode (G) to 1 cm, the distance (L) of the Detector (D) from the sonotrode tip is in this case the sum of 9 cm of water, 2mm of borosilicate glass, 4 mm of Plexiglas and 3 cm of air. The two vertical cylinders (A and B) contained one neutron detector each, of the same type of the three horizontal ones. The detectors were surrounded, and hence screened, by 3 cm of Boron powder (B) (thermal neutron absorber) and by 3 cm of Carbon powder (A) (neutron moderator), respectively. The distance (J) of these two screened Defenders XL from the axis of the vessel was the sum of the diameter of the bottle (water) plus the thickness of the borosilicate glass (2 mm), 10 cm of air, 1 mm of PVC and 3 cm of either Boron or Carbon. Two geiger counters (H and I) were pointed towards the bottom of the cavitation chamber, one with unscreened mica window, the other with a shield of 3mm of Aluminium. The distance of the mica window from the sonotrode tip was again (L) as specified above. In all of the six experiments of this second investigation, the three horizontal, unscreened Defender XL's measured a neutron emission significantly higher than the background level. The two vertical, screened Defender XL's (both by boron and carbon) always detected a reduced neutron dose, comparable with the background one (thus again providing further evidence of the neutron origin of the bubble signals). For all of the six experiments, we plotted the measured doses of neutrons (in nano-Sievert) as function of the cavitation time. The number of bubbles was counted every 10 min. Each curve corresponds to one concentration of the  $\text{Fe}(\text{NO}_3)_3$  solution, from 0 ppm to 10 ppm, and one oscillation amplitude (and therefore ultrasonic power), 50% (100 W) or 70% (130 W). The six graphs are reported in Fig. 6.

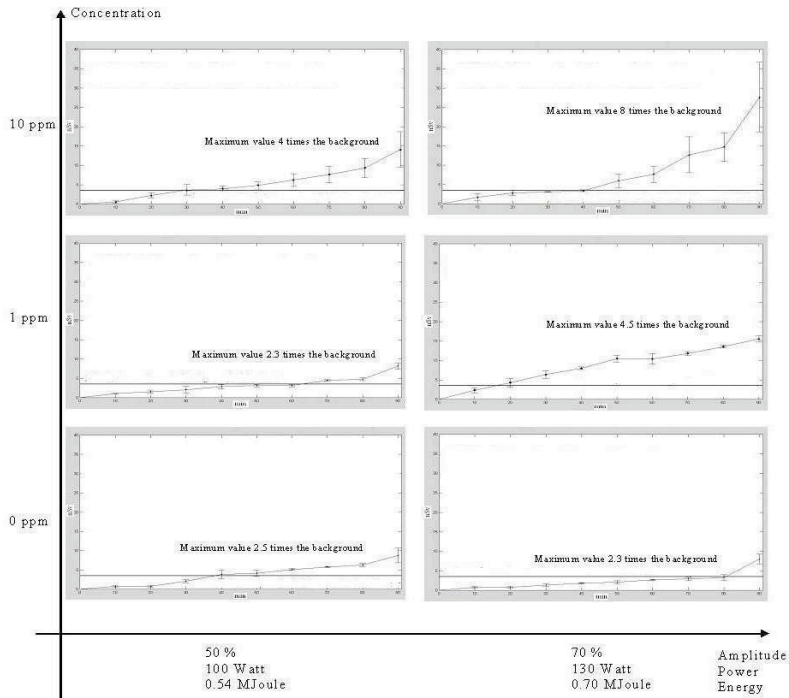

**Fig. 6:** The six graphs (one for each cavitation of the second series) showing the neutron dose (in nSv) as a function of time in minutes (time interval 10 min). Each curve corresponds to one value of concentration and one of the amplitude. The horizontal line in all graphs corresponds to the thermodynamical noise of 3.5 nSv. The graphs are displaced in a Cartesian plane, with concentration (in ppm) on the y-axis and amplitude (power) on the x-axis.

They are displaced in a Cartesian coordinate system with concentration on the y-axis and amplitude (power) on the x-axis. As in the first investigation, the horizontal black line represents the sum of the measured thermodynamical instability of the detectors and of the measured neutron background level. The examination of the six graphs of Fig. 6 does not report the threshold behaviour in energy that we found in the first investigation, namely the sharp and sudden increase of the curve

derivative in the last 30 minutes of cavitation. Despite that, according to our heuristic hypothesis (which will be experimentally supported in the following) about the neutron emission taking place in bursts, it will be wrong to interpret these curves as a sign of a stable neutron emission. Conversely, still considering valid this hypothesis, one can ascribe this different behaviour between the first and the second investigations to the different immersions of the sonotrode in the solution, which was about 4 cm (about 5 cm from the bottom of the vessel) in the former and only 1 cm (about 10 cm from the bottom of the vessel) in the latter. This means that both the height of the neutron peaks (bursts) and, hence, the emitted dose can be controlled somehow by this geometrical parameter. This consideration allows one to ascribe this apparent lack of threshold behaviour to the reduced height of the neutron peaks emitted during the cavitations performed in the second investigation with respect to those emitted in the first one. This reduced height spread the neutron dose over a longer period of time preventing the threshold behaviour from showing up. It will be the purpose of our future investigations to establish the time of appearance of the first neutron burst and verify whether it takes place beyond the energy (or time) threshold. Moreover, Fig. 6 further disproves the possible criticism about a possible generation of the bubbles by ultrasounds rather than by neutrons. Indeed, by looking at the compound graph and reading it along its columns, i.e. keeping the amplitude (power) fixed, it is seen that the curves are different, while the ultrasonic power is always the same. Conversely, had ultrasounds been the real cause of the bubbles, one should have had equal effects. Besides, we add that the temperature of the laboratory was stabilized to 20°C by a heat pump, which could work in reverse mode as well. Moreover, we checked every ten minutes the temperature of the body of the two defenders XL next to the cavitation chamber and in particular of that part close to the warm vessel. The temperature of this part increased gradually from 20°C but never exceeded 25°C which is perfectly within the working range (15°- 35°C ) guaranteed by the manufacturer who thermally stabilized their operation. As a further proof against any possible influence of temperature or IR irradiation on the number of bubbles in the defenders, we checked that at equal temperature of the solution in the vessel, and equal ultrasonic power, the bubble distribution in the defender XL did not show any systematic concentrations (qualitatively and quantitatively in term of number of bubbles) near the warmest part of the vessel and in the surroundings where possible thermal gradients might

have had some effect on the stability of the defenders. Let us also remark that in the second investigation one got evidence for neutron emission also in cavitating pure water, unlike the case of the first one. This is obviously due to the higher sensitivity of the detectors employed in the second investigation. Such a result agrees with the indirect evidence for neutron emission obtained in the first experiment of water cavitation, in which the changes in concentration of the stable elements occurred with a variation in neutron number [4, 5]. At the light of the above results, we can say that the cavitating device behaves as an ultrasonic nuclear reactor. As we have already said, we performed measurements of the ionizing radiation by means of the above mentioned (filtered and unfiltered) Geiger counters. The measured radiation was always compatible with the background level. As a further check of the absence of  $\gamma$  radiation, we carried out, in absence of cavitation and during cavitation of Iron Nitrate (70% amplitude, concentration  $>10$  ppm, duration 90 mins), simultaneous measurements by means of the two Geigers and through a thallium (Tl) activated, Sodium Iodine (NaI),  $\gamma$ -ray spectrometer. We found again a perfect compatibility between the background spectrum and that during cavitation both for the two Geigers and for the NaI (Tl),  $\gamma$ -ray spectrometer (in spite of the neutron signal with maximum of  $(9.1 \pm 0.5)$  nSv measured by the Defender XL's). Thus, the results of the second investigation too provided evidence for the emission of anomalous nuclear radiation, since neutrons were not accompanied by gamma rays. These outcomes about the apparent absence of gamma rays have to be commented by what we have already said above for the first investigation. The NaI(Tl) spectrometer allowed us to increase by several orders of magnitude the accuracy and sensitivity of gamma ray detection. Despite that, we need again to raise the question about the lack of gamma rays from Hydrogen capture which will have to be addressed to the future experiments.

The systematic analysis carried out by cavitating water solutions of Iron Nitrate, for all of which evidence of neutron radiation was gotten, shows that the phenomenon is perfectly reproducible. Moreover, we have been able, by changing the immersion depth of the sonotrode tip, to reduce the emitted neutron dose by one order of magnitude. In fact, in the last cavitation run we got a maximum of  $(28.0 \pm 7)$  nSv. This implies that the phenomenon can be somehow controlled.



### 3.3 Further check and features of neutron emission

In the previous two investigations, the evidence for neutron emission was highlighted by means of the detectors Defender through the analysis of the bubble signals. As a further check, we carried out a further experiment utilizing not only the Defender XL's but also boron-screened CR39 detectors according to a well known technique [22, 23, 24]. By the same experimental apparatus used in the second investigation (see Fig.??), we subjected to cavitation 250 ml of a water solution of Iron Chloride ( $\text{FeCl}_3$ ) with concentration 10 ppm. The cavitation lasted 90 min at the ultrasound frequency of 20 KHz, with oscillation amplitude of 70% of the maximum amplitude, corresponding to a power of 130 W (namely to a total energy of 0.70 MJ). The choice to use again a solution of  $\text{FeCl}_3$  was due to the fact that, all the other conditions being equal, we noted that with Iron Chloride there is a higher release of macroscopic energy than with Iron Nitrate (the liquid evaporation is from 2 to 5 times that observed with the latter solution). Due to the equality of thermodynamical conditions, this cannot be explained in terms of ultrasounds only. The two unscreened lateral Defender XL's (C and E) measured a maximum dose of neutrons of 14.5 nSv, 4 times higher than the detector thermodynamic noise of 3.5 nSv. Moreover, we placed, externally to the cavitation chamber, two pairs of 1 cm by 1 cm plate CR39 detectors (R,S and T,U) as shown in Fig. 7.

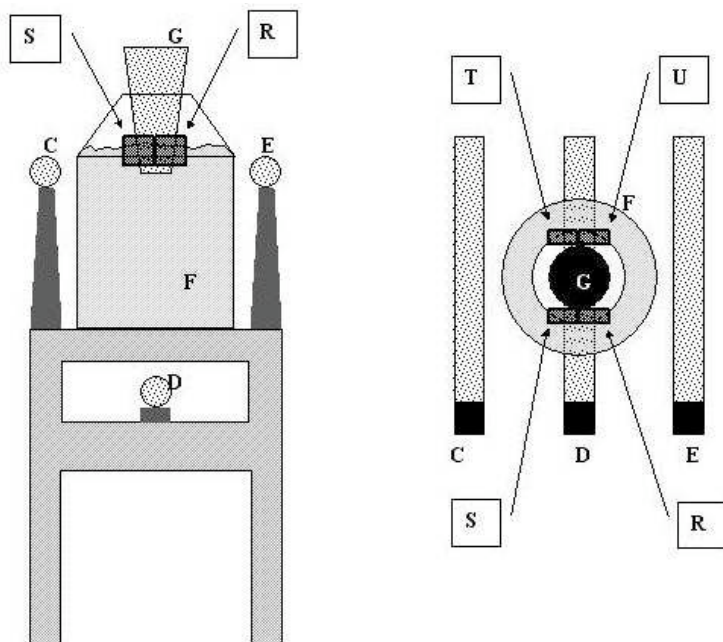

**Fig. 7:** Layout of the experimental setup of the second investigation showing the position of the boron screened CR39 plates with respect to the rest of the equipment.

Each plate was at a distance of about 4 cm from the vertical axis of the cavitation chamber, at the same level of the sonotrode tip. In between the CR39 plates and the axis of the vessel there were 3.5 cm of the solution, 2 mm of the borosilicate glass and about either 3 mm of air or 3 mm of Boron. The two couples were diametrically opposite to each other. In each pair, a CR39 was in air (S and T), whereas the other detector was immersed in boron (R and U) (whose interaction with neutrons gives rise to alpha radiation to which CR39 are sensitive). The results obtained are displayed in the second and third row of Fig. 8. By the boron CR39 we were able to detect neutrons with energies below 10 KeV too and, above all, thermal neutrons.

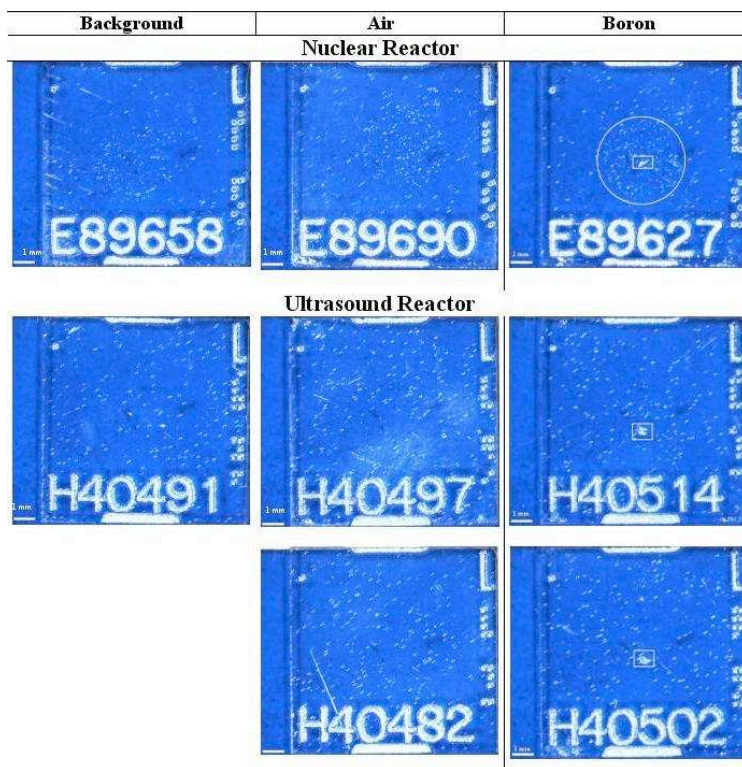

**Fig. 8:** Showing the traces left by neutrons on the CR39 detecting plates for the two cases of the nuclear reactor TAPIRO and the ultrasonic reactor. The magnification is 10X. The three columns from left to right refer, respectively, to the background, the CR39 in air and the CR39 immersed in boron. In the third column, the rectangles enclose the traces of the maximum neutron intensity (corresponding to the beam axis in the case of the nuclear reactor).

In order to have an idea of what the traces should look like on these detectors after etching, four more detectors were irradiated by neutrons using as source, the fast neutron nuclear reactor TAPIRO at Casaccia ENEA Rome, the neutron equivalent dose conveyed onto the detectors was  $2.1 \mu\text{Sv}$  through a diagnostic neutron channel<sup>8</sup>. The output channel

<sup>8</sup>Not knowing what kind of neutron spectrum to expect from the cavitated solution, as already stated, we decided to produce our comparison model of traces by a

of TAPIRO was calibrated to get a neutron equivalent dose rate of 21  $\mu\text{Sv/h}$ . A boron CR39 was used to measure the background level around the reactor, other two, one in air and the other immersed in boron, were placed at about 3 m from the reactor core and radiated for 5 min. The results are shown in the first row of Fig. 8. The comparison between the traces produced by neutrons in the CR39 immersed in boron (third column) in the nuclear reactor case (first row) and in the ultrasound one (second and third row) shows that their pattern (although not their extension) is perfectly similar. It is also possible to notice that the area of the thick trace produced by the reactor neutrons is about half of the areas of the thick traces produced by the neutrons generated by ultrasounds during cavitation. The Boron CR39 detectors can reveal neutrons of any energy. While fast neutrons are not affected by Boron and leave their own traces on the polycarbonate surface, slow neutrons and thermal neutrons, above all, convert into alpha particles by interacting with Boron-10 ( $^{10}\text{B}$ ) (according to  $^{10}\text{B}(n,\alpha)^7\text{Li}$ ) and through this mechanism produce a much wider and deeper trace on the polycarbonate surface than fast neutrons. If we use this fact and we compare the CR39 traces obtained in this experiment (compatible with equivalent doses of 4-5  $\mu\text{Sv}$  in 90 minutes), with the bubble signals collected by the Defender XL's in this same experiment (14.5 nSv in 90 minutes), and with those by the Defenders of the first Investigation (between 80 and 100 nSv in 90 minutes), we are allowed to conclude that the bulk of the neutron emission corresponds to neutrons having energy in the low epithermal range and even lower. We believe that the outcomes shown by these photos represent a fairly sound proof to corroborate our heuristic hypothesis about the emission of neutrons in bursts. The trace pattern together with the thick trace on the CR39 plate (like the third from left in Fig. 8), that was in front of the nuclear reactor, suggests that the emission of neutrons from the reactor core is constant and isotropic. Of course, the reactor channel acted as a filter which selected those neutrons whose velocity was almost parallel to the channel axis. These neutrons produced the thick track right on

---

source whose spectrum were the widest possible, i.e. a nuclear reactor. According to [22] these kind of detectors can detect fast, epithermal and thermal neutrons with different sensitivities of course. Hence the integral effect on the detectors, due to almost the whole neutron spectrum, would be traces whose quantity and shape would be compared to those obtained from the piezonuclear reactor. As already stated, the main target of these investigations is to reveal the presence of neutrons in a sort of a 'yes or no' detecting procedure. In future investigations we will perform more quantitatively accurate measurements by calibrating the CR39 detectors by known neutron energy sources.

the channel axis and that almost circular distribution highlighted on the third plate, but somehow visible on the second one too. These effects were collected within 5 minutes. On the contrary, despite the cylindrical symmetry of our experimental equipment (the vessel and the sonotrode), it is fairly clear that the neutron emission during cavitation was neither constant nor isotropic. Were it isotropic, one would have got a more uniform distribution of traces and more thick traces on the CR39 plates and a more uniform distribution of bubbles in the defenders. As to the constancy of emission, one would face the fact that the microscopical mechanism that brings about neutron emission is bubble collapse, which is governed by quite a few variables, like bubble dimension, quantity and type of atoms on the bubble surface. All these variables, completely uncontrolled yet, make neutron emission more likely an impuled process rather than constant. In this sense, neutron emission takes place in bursts at different instants of time, along diverse space directions and with different height and energy spectrum.

#### 4 Coherence with the findings of other experiments

Our cavitation experiments performed in the last decade evidenced two kinds of phenomena: production of nuclides (experiments [4, 5, 6]) and neutron emission (present experiments). Let us discuss such findings in connection with the results of other experiments. As to nuclide production, the findings of the previous experiments (in particular of the first one [4, 5]) are similar under many respects to those obtained by Russian teams at Kurchatov Institute and at Dubna JINR [25, 26, 27, 28, 29] in the experimental study of electric explosion of titanium foils in liquids. In a first experiment carried out in water, the Kurchatov group [25, 26] observed change in concentrations of chemical elements and the absence of significant radioactivity. These results have been subsequently confirmed at Dubna [27]. Subsequently, the experiments have been carried out in a solution of uranyl sulfate in distilled water, unambiguously showing [28] a distortion of the initial isotopic relationship of uranium and a violation of the secular equilibrium of  $^{234}\text{Th}$ . Further experiments are presently being carried out at the Nantes GeM laboratory, and their preliminary results are in agreement with those obtained by Urutskoev et al.[30]. Due to the similarity of such results with ours, in our opinion the two observed phenomena have a common origin. Namely, one might argue that the shock waves caused by the foil explosion in liquids act on the matter in a way similar to ultrasounds in cavitation.

In other words, the results of the Russian teams support the evidence for piezonuclear reactions<sup>9</sup>. However, let us notice that this is by no means a completely new result. Indeed, we recall that in the past some investigations [32, 33, 34, 35] have highlighted the ability of pressure and shock waves to generate autocatalytic fission-fusion reactions in compounds containing also uranium, tritium and deuterium. In such experiments, neutron fluxes have been observed in the range  $10^7$  - $10^{13}$  neutrons/cm<sup>2</sup>s. As to neutron emission, we already quoted the Oak Ridge experiment [8, 9, 10, 16] on possible nuclear fusion in deuterated acetone subjected to cavitation. The measured neutron flux was said to be compatible with d-d fusion during bubble collapse. Some authors disclaimed the results [11], others conversely confirmed them [12, 15]. As to what the results of our investigations are, one would not be surprised of the controversial results and hence opinions on the outcomes of the Oak Ridge experiments [8, 9, 10, 16]. Our outcomes show that neutron emission is obtained by cavitating solutions containing Iron and, even if in a very small quantity, by cavitating pure water. Hence the effects, that we measured, must be brought about by almost thoroughly unknown mechanisms which are triggered by pressure. With this in mind, we believe that whoever tried to reproduce the Oak Ridge experiments must have faced unusual behaviours and results since along with the very well known and expected neutrons from D-D fusion, other unknown effects (like the existence of a time (energy) threshold for neutron emission) would be superimposed, and would generate confused results which do not precisely confirm the common phenomenological predictions about fusion.

The experiments [8, 9, 10, 16] belong to the research stream known as sonofusion (or acoustic inertial confinement fusion), pioneered by Flynn in 1982 [2]. It amounts to the attempt to produce known nuclear reactions by means of ultrasounds and cavitation. Conversely our case is completely different. We produced new nuclear reactions (piezonuclear reactions) that involve heavy nuclei but do not, apparently, affect Hydrogen or light ones (at least within 90 minutes) under unusual conditions like the existence of an energy threshold for these reactions to happen and like the apparent lack of gamma emission concomitant to neutron emission (although this needs to be confirmed).

---

<sup>9</sup>Another possible interpretation proposed for such phenomena (at least for the titanium foil explosion) is in terms of the light magnetic monopoles introduced by Lochak[31].

## 5 Conclusion

The experiments we carried out permit therefore to conclude that the cavitation process is able to induce in Iron salt solutions emission of either fast and epithermal neutrons. This constitutes a further evidence for piezonuclear reactions. Moreover, we have been able to state some fundamental features of such a neutron emission, namely: 1) it exhibits threshold behavior in power, energy and time; 2) it occurs in anomalous conditions, namely without concomitant sensible production of  $\gamma$ -rays. If independently confirmed, our results would probably constitute a signature of new physics.

Let us conclude by putting forward a conjecture about these piezonuclear reactions and foretell that they can be brought about by properly compressing solid materials that contain iron (e.g. granite), for instance in one of those toughness experiments that are very common in Mechanical and Civil Engineerings. More precisely, it will be possible to measure neutron emission at the instant of fracture of the specimens of these materials as their compression increases and reaches the breaking load. According to what is being done for liquids, it will be necessary to study neutron emissions as function of the compression speed of the specimens.

**Acknowledgments.** We are greatly indebted to all people who supported us in many ways in carrying out the experiments: the military technicians of the Italian Armed Forces A. Aracu, A. Bellitto, F. Contalbo, P. Muraglia; M. T. Topi, Director of ARPA Laboratories of Viterbo; the following personnel of Casaccia ENEA Laboratories: P. Giampietro, Director, G. Rosi, responsible of the nuclear reactor "TAPIRO", and A. Santagata; G. Ingo and C. Ricucci, of the Microscopy Laboratory ISMN-CNR and L. Petrilli, of CNR-Rome 1 Area, Montelibretti, for performing the mass spectrometry of the cavitated samples; R. Capotosto, Department of Physics "E. Amaldi" of University "Roma Tre", for technical support on the sonotrode tip. On the theoretical side, invaluable comments by E. Pessa are gratefully acknowledged. Thanks are also due to F. Mazzuca, President of Ansaldo Nucleare, for deep interest and warm encouragement. Last but not least, it is both a duty and a pleasure to thank in a special way Fabio Pistella, former President of CNR (Italian National Research Council) for his caring assistance, continuous interest, convinced participation to all stages of the experiments, and eventually for his experience of nuclear physicist he kindly provided to us during the discussions concerning the experimental results.

## References

- [1] Crum, L., & Gaitan, D.F., *Frontiers of Nonlinear Acoustics*, 12th Int. Symp. on Nonlinear Acoustics (Elsevier Applied Science, New York, 1990).
- [2] Brennen, C.E., *Cavitation and bubble dynamics* (Oxford Univ. Press., 1995).
- [3] Metcalf, H., *Science* 279, 1322 (1998).
- [4] Cardone, F. & Mignani, R.: in Proc. Int. Conf. On Cosmoparticle Physics "Cosmion 2001" (Moscow, Russia, May 2001), *Grav. and Cosmol. Suppl.* 8, 216 (2002).
- [5] Cardone, F. & Mignani, R.: *Int. J. Mod. Phys. B* 17, 307 (2003).
- [6] Cardone, F., Mignani, R., Perconti, W., Pessa, E. & Spera, G.: *Jour. Radioanalytical Nucl. Chem.* 265, 151 (2005).
- [7] Cardone, F. & Mignani, R.: *Int. Jour. Modern Phys. E* 15, 911 (2006).
- [8] Taleyarkhan, R.P., et al., *Science* 295, 1868 (2002).
- [9] Taleyarkhan, R.P., et al., *Phys. Rev. E* 69, 036109 (2004).
- [10] Taleyarkhan, R.P., et al., *Phys. Rev. Lett.* 96, 034301 (2006).
- [11] Shapira, D., & Saltmarsh, M.: *Phys. Rev. Lett.* 89,104302 (2002).
- [12] Xua, Y. & Butt A.: *Nuclear Engineering and Design* 235, 1317 (2005).
- [13] Nigmatulin et al., *J. Power and Energy*, Vol. 218 Part A, 2004.
- [14] Nigmatulin et al., *Physics of Fluids*, 17, 107106, 2005.
- [15] E. Forringer et l., *Archives of American Nuclear Society*, Albuquerque, NM, pg.736-737, Nov.2006; also, *Proc. Of Int. Conf. Nuclear Fusion Energy*, Albuquerque, NM, Nov. 2006.
- [16] R. P. Taleyarkhan et al., *Nuclear Engineering and Design*, 238 (10), p.2779-2791, Oct 2008
- [17] <http://www.sonotronic.de/products/standard-machines/ultrasonic-generators-type-dn-35-m-md-and-dn-20-m-md>
- [18] <http://www.duran-group.com/english/products/duran/detail/laborflaschen.html>  
[http://www.duran-group.com/english/download/laborglas\\_katalog\\_2005\\_2\\_p029.pdf](http://www.duran-group.com/english/download/laborglas_katalog_2005_2_p029.pdf)
- [19] <http://www.gammascout.com/>
- [20] <http://www.amptek.com/gamma8k.html>
- [21] [http://www.bubbletech.ca/pdfs/BTL\\_BUBBLE\\_DEFENDER\\_October2006.pdf](http://www.bubbletech.ca/pdfs/BTL_BUBBLE_DEFENDER_October2006.pdf)
- [22] R. V. Griffith, D. E. Hankins, L. Tommasino, and M. A. M. Gomaa, *United States Patent* 4,381,454 April 26, (1983).
- [23] E. U. Khan, et al., *Radiation Measurements* 4, 2-6, 583-586, (2005).
- [24] M. Izerrouken, J. Skvarc, and R. Ilic, *Radiation Measurements* 37, 21-24 (2003).
- [25] Urutskoev L.L., Liksonov V.I. & Tsinoev V.G. , *Applied Physics (Russia)*, 4, 83 (2000).



- [26] Urutskoev L.L., Liksonov V.I. & Tsinoev V.G. ,Ann. Fond. L.de Broglie. 27, 701 (2002).
- [27] Kuznetsov, V.D., Myshinskii, G.V., Zhemennik, V.I. & Arbutov, V.I. : "Test Experiments on Observation of Cold Transmutation of Elements", Proc. 8-th Russ. Conf. on the Cold Transmutation of Nuclei of Chemical Elements (Moscow, 2001), p.308.
- [28] Volkovich, A.G., Govorun, A.P., Gulyaev, A.A., Zhukov, S.V., Kuznetsov, V.L., Rukhadze, A.A., Steblevskii, A.V. & Urutskoev, L.I.: Bull. Lebedev Physics Inst., 2002 (8).
- [29] For a review, see Urutskoev, L.I.: Ann. Fond. L.de Broglie 29, 1149 (2004).
- [30] Priem, D., G. Racineux, G., Lochak, G., Daviau, C., Fargue, D., M. Karatchentcheff, M. & H. Lehn, H.: Ann. Fond. L.de Broglie **33**, 129 (2008).
- [31] See e.g. Lochak, G.: Ann. Fond. L.de Broglie **33**, 1 (2008), and refs. therein.
- [32] Diebner, K.: Kerntechnik n.3, 89 (1962).
- [33] Kaliski, S.: Nature 269, 370 (1977).
- [34] Kozirev, A.S., Aleksandrov, V.A., Popov, N.A.: Nature 275, 476 (1978).
- [35] Winterberg, F.: Atomenergie-Kerntechnik 44, 146 (1984).

*(Manuscript reçu le 28 avril 2009)*